

**850MHz, Low Distortion, Output Limiting, Programmable Gain, Buffer Amplifier**

The HFA1113 is a high speed Buffer featuring user programmable gain and output limiting coupled with ultra high speed performance. This buffer is the ideal choice for high frequency applications requiring output limiting, especially those needing ultra fast overload recovery times. The output limiting function allows the designer to set the maximum positive and negative output levels, thereby protecting later stages from damage or input saturation. The sub-nanosecond overdrive recovery time quickly returns the amplifier to linear operation following an overdrive condition.

A unique feature of the pinout allows the user to select a voltage gain of +1, -1, or +2, without the use of any external components, as described in the "Application Information" section. Compatibility with existing op amp pinouts provides flexibility to upgrade low gain amplifiers, while decreasing component count. Unlike most buffers, the standard pinout provides an upgrade path should a higher closed loop gain be needed at a future date.

Component and composite video systems will also benefit from this buffer's performance, as indicated by the excellent gain flatness, and 0.02%/0.04 Degree Differential Gain/Phase specifications ( $R_L = 150\Omega$ ).

For Military product, refer to the HFA1113/883 data sheet.

**Ordering Information**

PART NUMBER (BRAND)	TEMP. RANGE (°C)	PACKAGE	PKG. NO.
HFA1113IB (H1113I)	-40 to 85	8 Ld SOIC	M8.15
HFA11XXEVAL	DIP Evaluation Board For High Speed Op Amps		

**Pinout**

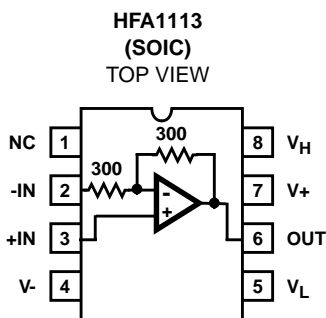

**Features**

- User Programmable Output Voltage Limiting
- User Programmable For Closed-Loop Gains of +1, -1 or +2 Without Use of External Resistors
- Wide -3dB Bandwidth. . . . . 850MHz
- Excellent Gain Flatness (to 100MHz). . . . .  $\pm 0.07\text{dB}$
- Low Differential Gain and Phase . . . 0.02%/0.04 Degrees
- Low Distortion (HD3, 30MHz). . . . . -73dBc
- Very Fast Slew Rate . . . . . 2400V/ $\mu\text{s}$
- Fast Settling Time (0.1%) . . . . . 13ns
- High Output Current . . . . . 60mA
- Excellent Gain Accuracy . . . . . 0.99V/V
- Overdrive Recovery . . . . . <1ns
- Standard Operational Amplifier Pinout

**Applications**

- RF/IF Processors
- Driving Flash A/D Converters
- High-Speed Communications
- Impedance Transformation
- Line Driving
- Video Switching and Routing
- Radar Systems
- Medical Imaging Systems

**Pin Descriptions**

NAME	PIN NUMBER	DESCRIPTION
NC	1	No Connection
-IN	2	Inverting Input
+IN	3	Non-Inverting Input
V-	4	Negative Supply
V <sub>L</sub>	5	Lower Output Limit
OUT	6	Output
V+	7	Positive Supply
V <sub>H</sub>	8	Upper Output Limit

**Absolute Maximum Ratings**

Voltage Between V+ and V- .....12V  
 DC Input Voltage .....  $V_{SUPPLY}$   
 Voltage at V<sub>H</sub> or V<sub>L</sub> Terminal ..... (V+) + 2V to (V-) - 2V  
 Output Current (50% Duty Cycle) ..... 60mA

**Operating Conditions**

Temperature Range ..... -40°C to 85°C

**Thermal Information**

Thermal Resistance (Typical, Note 1)  $\theta_{JA}$  (°C/W)  
 SOIC Package ..... 158  
 Maximum Junction Temperature (Plastic Package) ..... 150°C  
 Maximum Storage Temperature Range ..... -65°C to 150°C  
 Maximum Lead Temperature (Soldering 10s) ..... 300°C  
 (SOIC - Lead Tips Only)

*CAUTION: Stresses above those listed in "Absolute Maximum Ratings" may cause permanent damage to the device. This is a stress only rating and operation of the device at these or any other conditions above those indicated in the operational sections of this specification is not implied.*

**NOTE:**

1.  $\theta_{JA}$  is measured with the component mounted on an evaluation PC board in free air.

**Electrical Specifications**  $V_{SUPPLY} = \pm 5V, A_V = +1, R_L = 100\Omega$ , Unless Otherwise Specified

PARAMETER	TEST CONDITIONS	TEMP. (°C)	MIN	TYP	MAX	UNITS
<b>INPUT CHARACTERISTICS</b>						
Output Offset Voltage		25	-	8	25	mV
		Full	-	-	35	mV
Output Offset Voltage Drift		Full	-	10	-	$\mu V/^\circ C$
PSRR		25	39	45	-	dB
		Full	35	-	-	dB
Input Noise Voltage (Note 3)	100kHz	25	-	9	-	$nV/\sqrt{Hz}$
+Input Noise Current (Note 3)	100kHz	25	-	37	-	$pA/\sqrt{Hz}$
Non-Inverting Input Bias Current		25	-	25	40	$\mu A$
		Full	-	-	65	$\mu A$
Non-Inverting Input Resistance		25	25	50	-	k $\Omega$
Inverting Input Resistance (Note 2)		25	240	300	360	$\Omega$
Input Capacitance		25	-	2	-	pF
Input Common Mode Range		Full	$\pm 2.5$	$\pm 2.8$	-	V
<b>TRANSFER CHARACTERISTICS</b>						
Gain	$A_V = +1, V_{IN} = +2V$	25	0.980	0.990	1.020	V/V
		Full	0.975	-	1.025	V/V
	$A_V = +2, V_{IN} = +1V$	25	1.96	1.98	2.04	V/V
		Full	1.95	-	2.05	V/V
DC Non-Linearity (Note 3)	$A_V = +2, \pm 2V$ Full Scale	25	-	0.02	-	%
<b>OUTPUT CHARACTERISTICS</b>						
Output Voltage (Note 3)	$A_V = -1$	25	$\pm 3.0$	$\pm 3.3$	-	V
		Full	$\pm 2.5$	$\pm 3.0$	-	V
Output Current (Note 3)	$R_L = 50\Omega$	25, 85	50	60	-	mA
		-40	35	50	-	mA
Closed Loop Output Impedance	DC, $A_V = +2$	25	-	0.3	-	$\Omega$
<b>POWER SUPPLY CHARACTERISTICS</b>						
Supply Voltage Range		Full	$\pm 4.5$	-	$\pm 5.5$	V
Supply Current (Note 3)		25	-	21	26	mA
		Full	-	-	33	mA

# HFA1113

## Electrical Specifications $V_{SUPPLY} = \pm 5V$ , $A_V = +1$ , $R_L = 100\Omega$ , Unless Otherwise Specified (Continued)

PARAMETER	TEST CONDITIONS	TEMP. (°C)	MIN	TYP	MAX	UNITS
<b>AC CHARACTERISTICS</b>						
-3dB Bandwidth ( $V_{OUT} = 0.2V_{P-P}$ , Notes 2, 3)	$A_V = -1$	25	450	800	-	MHz
	$A_V = +1$	25	500	850	-	MHz
	$A_V = +2$	25	350	550	-	MHz
Slew Rate ( $V_{OUT} = 5V_{P-P}$ , Note 2)	$A_V = -1$	25	1500	2400	-	V/ $\mu$ s
	$A_V = +1$	25	800	1500	-	V/ $\mu$ s
	$A_V = +2$	25	1100	1900	-	V/ $\mu$ s
Full Power Bandwidth ( $V_{OUT} = 5V_{P-P}$ , Note 3)	$A_V = -1$	25	-	300	-	MHz
	$A_V = +1$	25	-	150	-	MHz
	$A_V = +2$	25	-	220	-	MHz
Gain Flatness (to 30MHz, Notes 2, 3)	$A_V = -1$	25	-	$\pm 0.02$	-	dB
	$A_V = +1$	25	-	$\pm 0.1$	-	dB
	$A_V = +2$	25	-	$\pm 0.015$	$\pm 0.04$	dB
Gain Flatness (to 50MHz, Notes 2, 3)	$A_V = -1$	25	-	$\pm 0.05$	-	dB
	$A_V = +1$	25	-	$\pm 0.2$	-	dB
	$A_V = +2$	25	-	$\pm 0.036$	$\pm 0.08$	dB
Gain Flatness (to 100MHz, Notes 2, 3)	$A_V = -1$	25	-	$\pm 0.10$	-	dB
	$A_V = +2$	25	-	$\pm 0.07$	$\pm 0.22$	dB
Linear Phase Deviation (to 100MHz, Note 3)	$A_V = -1$	25	-	$\pm 0.13$	-	Degrees
	$A_V = +1$	25	-	$\pm 0.83$	-	Degrees
	$A_V = +2$	25	-	$\pm 0.05$	-	Degrees
2nd Harmonic Distortion (30MHz, $V_{OUT} = 2V_{P-P}$ , Notes 2, 3)	$A_V = -1$	25	-	-52	-	dBc
	$A_V = +1$	25	-	-57	-	dBc
	$A_V = +2$	25	-	-52	-45	dBc
3rd Harmonic Distortion (30MHz, $V_{OUT} = 2V_{P-P}$ , Notes 2, 3)	$A_V = -1$	25	-	-71	-	dBc
	$A_V = +1$	25	-	-73	-	dBc
	$A_V = +2$	25	-	-72	-65	dBc
2nd Harmonic Distortion (50MHz, $V_{OUT} = 2V_{P-P}$ , Notes 2, 3)	$A_V = -1$	25	-	-47	-	dBc
	$A_V = +1$	25	-	-53	-	dBc
	$A_V = +2$	25	-	-47	-40	dBc
3rd Harmonic Distortion (50MHz, $V_{OUT} = 2V_{P-P}$ , Notes 2, 3)	$A_V = -1$	25	-	-63	-	dBc
	$A_V = +1$	25	-	-68	-	dBc
	$A_V = +2$	25	-	-65	-55	dBc
2nd Harmonic Distortion (100MHz, $V_{OUT} = 2V_{P-P}$ , Notes 2, 3)	$A_V = -1$	25	-	-41	-	dBc
	$A_V = +1$	25	-	-50	-	dBc
	$A_V = +2$	25	-	-42	-35	dBc
3rd Harmonic Distortion (100MHz, $V_{OUT} = 2V_{P-P}$ , Notes 2, 3)	$A_V = -1$	25	-	-55	-	dBc
	$A_V = +1$	25	-	-49	-	dBc
	$A_V = +2$	25	-	-62	-45	dBc

# HFA1113

## Electrical Specifications $V_{SUPPLY} = \pm 5V$ , $A_V = +1$ , $R_L = 100\Omega$ , Unless Otherwise Specified (Continued)

PARAMETER	TEST CONDITIONS	TEMP. (°C)	MIN	TYP	MAX	UNITS
3rd Order Intercept ( $A_V = +2$ , Note 3)	100MHz	25	-	28	-	dBm
	300MHz	25	-	13	-	dBm
1dB Compression ( $A_V = +2$ , Note 3)	100MHz	25	-	19	-	dBm
	300MHz	25	-	12	-	dBm
Reverse Isolation ( $S_{12}$ , Note 3)	40MHz	25	-	-70	-	dB
	100MHz	25	-	-60	-	dB
	600MHz	25	-	-32	-	dB
<b>TRANSIENT CHARACTERISTICS</b>						
Rise Time ( $V_{OUT} = 0.5V$ Step, Note 2)	$A_V = -1$	25	-	500	800	ps
	$A_V = +1$	25	-	480	750	ps
	$A_V = +2$	25	-	700	1000	ps
Rise Time ( $V_{OUT} = 2V$ Step)	$A_V = -1$	25	-	0.82	-	ns
	$A_V = +1$	25	-	1.06	-	ns
	$A_V = +2$	25	-	1.00	-	ns
Overshoot ( $V_{OUT} = 0.5V$ Step, Input $t_R/t_F = 200ps$ , Notes 2, 3, 4)	$A_V = -1$	25	-	12	30	%
	$A_V = +1$	25	-	45	65	%
	$A_V = +2$	25	-	6	20	%
0.1% Settling Time (Note 3)	$V_{OUT} = 2V$ to $0V$	25	-	13	20	ns
0.05% Settling Time	$V_{OUT} = 2V$ to $0V$	25	-	20	33	ns
Differential Gain	$A_V = +1$ , 3.58MHz, $R_L = 150\Omega$	25	-	0.03	-	%
	$A_V = +2$ , 3.58MHz, $R_L = 150\Omega$	25	-	0.02	-	%
Differential Phase	$A_V = +1$ , 3.58MHz, $R_L = 150\Omega$	25	-	0.05	-	Degrees
	$A_V = +2$ , 3.58MHz, $R_L = 150\Omega$	25	-	0.04	-	Degrees
<b>OUTPUT LIMITING CHARACTERISTICS</b> $A_V = +2$ , $V_H = +1V$ , $V_L = -1V$ , Unless Otherwise Specified						
Clamp Accuracy (Note 3)	$V_{IN} = \pm 1.6V$ , $A_V = -1$	25	-	$\pm 100$	$\pm 150$	mV
		Full	-	-	$\pm 200$	mV
Clamp Overshoot	$V_{IN} = \pm 1V$ , Input $t_R/t_F = 500ps$	25	-	7	-	%
Overdrive Recovery Time (Note 3)	$V_{IN} = \pm 1V$	25	-	0.75	1.5	ns
Negative Clamp Range		25	-	-5.0 to +2.0	-	V
Positive Clamp Range		25	-	-2.0 to +5.0	-	V
Clamp Input Bias Current (Note 3)		25	-	50	200	$\mu A$
		Full	-	-	300	$\mu A$
Clamp Input Bandwidth (Note 3)	$V_H$ or $V_L = 100mV_{P-P}$	25	-	500	-	MHz

**NOTES:**

2. This parameter is not tested. The limits are guaranteed based on lab characterization, and reflect lot-to-lot variation.
3. See Typical Performance Curves for more information.
4. Overshoot decreases as input transition times increase, especially for  $A_V = +1$ . Please refer to Typical Performance Curves.

## Application Information

### Closed Loop Gain Selection

The HFA1113 features a novel design which allows the user to select from three closed loop gains, without any external components. The result is a more flexible product, fewer part types in inventory, and more efficient use of board space.

This “buffer” operates in closed loop gains of -1, +1, or +2, and gain selection is accomplished via connections to the  $\pm$ Inputs. Applying the input signal to +IN and floating -IN selects a gain of +1, while grounding -IN selects a gain of +2. A gain of -1 is obtained by applying the input signal to -IN with +IN grounded.

The table below summarizes these connections:

GAIN ( $A_{CL}$ )	CONNECTIONS	
	+INPUT (PIN 3)	-INPUT (PIN 2)
-1	GND	Input
+1	Input	NC (Floating)
+2	Input	GND

### PC Board Layout

The frequency response of this amplifier depends greatly on the amount of care taken in designing the PC board. **The use of low inductance components such as chip resistors and chip capacitors is strongly recommended, while a solid ground plane is a must!**

Attention should be given to decoupling the power supplies. A large value (10 $\mu$ F) tantalum in parallel with a small value chip (0.1 $\mu$ F) capacitor works well in most cases.

Terminated microstrip signal lines are recommended at the input and output of the device. Capacitance directly on the output must be minimized, or isolated as discussed in the next section.

For unity gain applications, care must also be taken to minimize the capacitance to ground seen by the amplifier's inverting input. At higher frequencies this capacitance will tend to short the -INPUT to GND, resulting in a closed loop gain which increases with frequency. This will cause excessive high frequency peaking and potentially other problems as well.

An example of a good high frequency layout is the Evaluation Board shown in Figure 3.

### Driving Capacitive Loads

Capacitive loads, such as an A/D input, or an improperly terminated transmission line will degrade the amplifier's phase margin resulting in frequency response peaking and possible oscillations. In most cases, the oscillation can be

avoided by placing a resistor ( $R_S$ ) in series with the output prior to the capacitance.

Figure 1 details starting points for the selection of this resistor. The points on the curve indicate the  $R_S$  and  $C_L$  combinations for the optimum bandwidth, stability, and settling time, but experimental fine tuning is recommended. Picking a point above or to the right of the curve yields an overdamped response, while points below or left of the curve indicate areas of underdamped performance.

$R_S$  and  $C_L$  form a low pass network at the output, thus limiting system bandwidth well below the amplifier bandwidth of 850MHz. By decreasing  $R_S$  as  $C_L$  increases (as illustrated in the curves), the maximum bandwidth is obtained without sacrificing stability. Even so, bandwidth does decrease as you move to the right along the curve. For example, at  $A_V = +1$ ,  $R_S = 50\Omega$ ,  $C_L = 30\text{pF}$ , the overall bandwidth is limited to 300MHz, and bandwidth drops to 100MHz at  $A_V = +1$ ,  $R_S = 5\Omega$ ,  $C_L = 340\text{pF}$ .

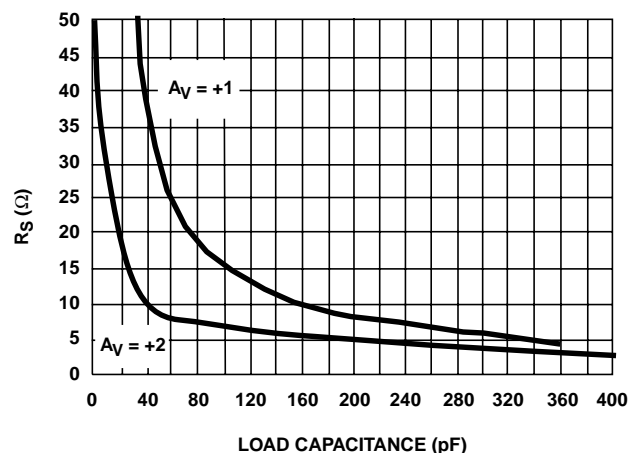

FIGURE 1. RECOMMENDED SERIES RESISTOR vs LOAD CAPACITANCE

### Evaluation Board

The performance of the HFA1113 may be evaluated using the HFA11XX Evaluation Board, slightly modified as follows:

1. Remove the 500 $\Omega$  feedback resistor ( $R_2$ ), and leave the connection open.
2. a. For  $A_V = +1$  evaluation, remove the 500 $\Omega$  gain setting resistor ( $R_1$ ), and leave pin 2 floating.  
b. For  $A_V = +2$ , replace the 500 $\Omega$  gain setting resistor with a 0 $\Omega$  resistor to GND.

The modified schematic and layout of the board are shown in Figures 2 and 3.

To order evaluation boards (part number HFA11XXEVAL), please contact your local sales office.

NOTE: The SOIC version may be evaluated in the DIP board by using a SOIC-to-DIP adapter such as Aries Electronics Part Number 08-350000-10.

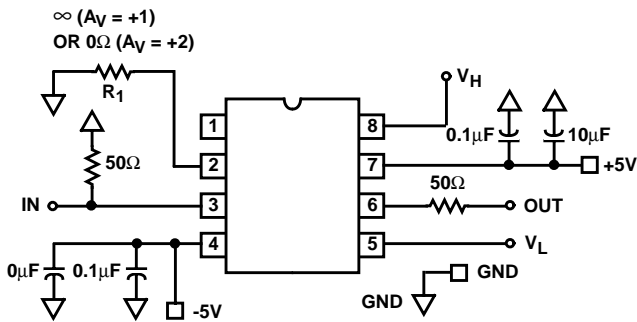

FIGURE 2. MODIFIED EVALUATION BOARD SCHEMATIC

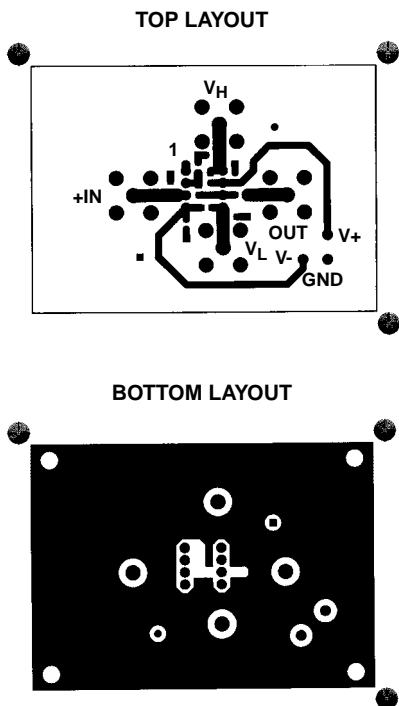

FIGURE 3. EVALUATION BOARD LAYOUT

### Limiting Operation

#### General

The HFA1113 features user programmable output clamps to limit output voltage excursions. Clamping action is obtained by applying voltages to the  $V_H$  and  $V_L$  terminals (pins 8 and 5) of the amplifier.  $V_H$  sets the upper output limit, while  $V_L$  sets the lower clamp level. If the amplifier tries to drive the output above  $V_H$ , or below  $V_L$ , the clamp circuitry limits the output voltage at  $V_H$  or  $V_L$  ( $\pm$  the clamp accuracy), respectively. The low input bias currents of the clamp pins allow them to be driven by simple resistive divider circuits, or active elements such as amplifiers or DACs.

#### Clamp Circuitry

Figure 4 shows a simplified schematic of the HFA1113 input stage, and the high clamp ( $V_H$ ) circuitry. As with all current feedback amplifiers, there is a unity gain buffer ( $Q_{X1} - Q_{X2}$ )

between the positive and negative inputs. This buffer forces  $-IN$  to track  $+IN$ , and sets up a slewing current of:

$$(V_{-IN} - V_{OUT})/R_F + V_{-IN}/R_G$$

This current is mirrored onto the high impedance node ( $Z$ ) by  $Q_{X3} - Q_{X4}$ , where it is converted to a voltage and fed to the output via another unity gain buffer. If no clamping is utilized, the high impedance node may swing within the limits defined by  $Q_{P4}$  and  $Q_{N4}$ . Note that when the output reaches its quiescent value, the current flowing through  $-IN$  is reduced to only that small current ( $-I_{BIAS}$ ) required to keep the output at the final voltage.

Tracing the path from  $V_H$  to  $Z$  illustrates the effect of the clamp voltage on the high impedance node.  $V_H$  decreases by  $2V_{BE}$  ( $Q_{N6}$  and  $Q_{P6}$ ) to set up the base voltage on  $Q_{P5}$ .

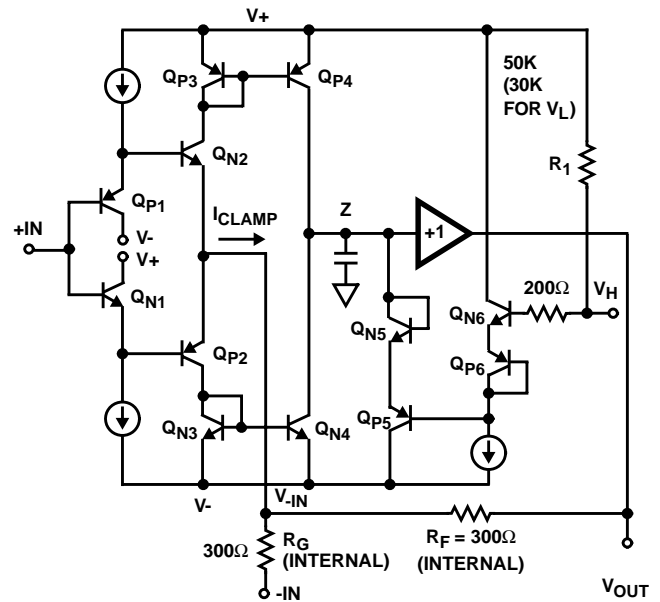

FIGURE 4. HFA1113 SIMPLIFIED  $V_H$  CLAMP CIRCUITRY

$Q_{P5}$  begins to conduct whenever the high impedance node reaches a voltage equal to  $Q_{P5}$ 's base voltage +  $2V_{BE}$  ( $Q_{P5}$  and  $Q_{N5}$ ). Thus,  $Q_{P5}$  clamps node  $Z$  whenever  $Z$  reaches  $V_H$ .  $R_1$  provides a pull-up network to ensure functionality with the clamp inputs floating. A similar description applies to the symmetrical low clamp circuitry controlled by  $V_L$ .

When the output is clamped, the negative input continues to source a slewing current ( $I_{CLAMP}$ ) in an attempt to force the output to the quiescent voltage defined by the input.  $Q_{P5}$  must sink this current while clamping, because the  $-IN$  current is always mirrored onto the high impedance node. The clamping current is calculated as:

$$I_{CLAMP} = (V_{-IN} - V_{OUT CLAMPED})/300\Omega + V_{-IN}/R_G.$$

As an example, a unity gain circuit with  $V_{IN} = 2V$ , and  $V_H = 1V$ , would have  $I_{CLAMP} = (2V - 1V)/300\Omega + 2V/\infty = 3.33mA$  ( $R_G = \infty$  because  $-IN$  is floated for unity gain applications). Note that  $I_{CC}$  will increase by  $I_{CLAMP}$  when the output is clamp limited.

**Clamp Accuracy**

The clamped output voltage will not be exactly equal to the voltage applied to  $V_H$  or  $V_L$ . Offset errors, mostly due to  $V_{BE}$  mismatches, necessitate a clamp accuracy parameter which is found in the device specifications. Clamp accuracy is a function of the clamping conditions. Referring again to Figure 4, it can be seen that one component of clamp accuracy is the  $V_{BE}$  mismatch between the  $Q_{X6}$  transistors, and the  $Q_{X5}$  transistors. If the transistors always ran at the same current level there would be no  $V_{BE}$  mismatch, and no contribution to the inaccuracy. The  $Q_{X6}$  transistors are biased at a constant current, but as described earlier, the current through  $Q_{X5}$  is equivalent to  $I_{CLAMP}$ .  $V_{BE}$  increases as  $I_{CLAMP}$  increases, causing the clamped output voltage to increase as well.  $I_{CLAMP}$  is a function of the overdrive level ( $A_{VCL} \times V_{IN} - V_{OUT\ CLAMPED}$ ), so clamp accuracy degrades as the overdrive increases. As an example, the specified accuracy of  $\pm 100mV$  ( $A_V = -1$ ,  $V_H = 1V$ ) for a 1.6X overdrive degrades to  $\pm 240mV$  for a 3X (200%) overdrive, as shown in Figure 43.

Consideration must also be given to the fact that the clamp voltages have an affect on amplifier linearity. The "Nonlinearity Near Clamp Voltage" curve, Figure 48, illustrates the impact of several clamp levels on linearity.

**Clamp Range**

Unlike some competitor devices, both  $V_H$  and  $V_L$  have usable ranges that cross 0V. While  $V_H$  must be more positive than  $V_L$ , both may be positive or negative, within the range

restrictions indicated in the specifications. For example, the HFA1113 could be limited to ECL output levels by setting  $V_H = -0.8V$  and  $V_L = -1.8V$ .  $V_H$  and  $V_L$  may be connected to the same voltage (GND for instance) but the result won't be in a DC output voltage from an AC input signal. A 150mV - 200mV AC signal will still be present at the output.

**Recovery from Overdrive**

The output voltage remains at the clamp level as long as the overdrive condition remains. When the input voltage drops below the overdrive level ( $V_{CLAMP}/A_{VCL}$ ) the amplifier will return to linear operation. A time delay, known as the Overdrive Recovery Time, is required for this resumption of linear operation. The plots of "Unclamped Performance" and "Clamped Performance" (Figures 41 and 42) highlight the HFA1113's subnanosecond recovery time. The difference between the unclamped and clamped propagation delays is the overdrive recovery time. The appropriate propagation delays are 8.0ns for the unclamped pulse, and 8.8ns for the clamped (2X overdrive) pulse yielding an overdrive recovery time of 800ps. The measurement uses the 90% point of the output transition to ensure that linear operation has resumed. Note: The propagation delay illustrated is dominated by the fixturing. The delta shown is accurate, but the true HFA1113 propagation delay is 500ps.

Overdrive recovery time is also a function of the overdrive level. Figure 47 details the overdrive recovery time for various clamp and overdrive levels.

**Typical Performance Curves**  $V_{SUPPLY} = \pm 5V$ ,  $T_A = 25^\circ C$ ,  $R_L = 100\Omega$ , Unless Otherwise Specified

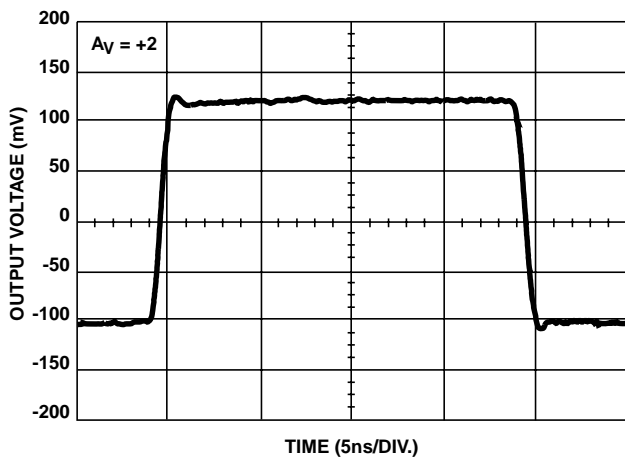

FIGURE 5. SMALL SIGNAL PULSE RESPONSE

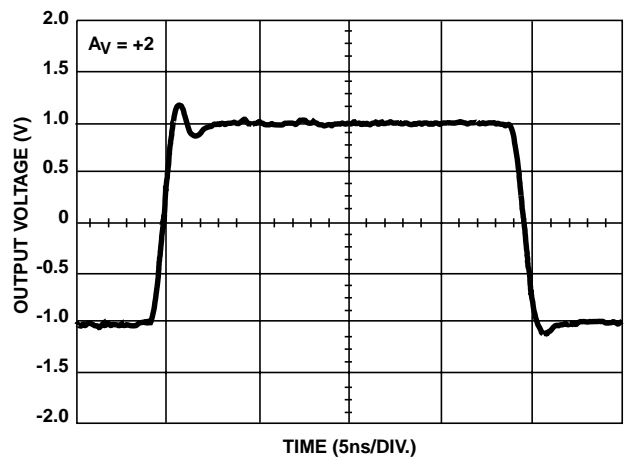

FIGURE 6. LARGE SIGNAL PULSE RESPONSE

**Typical Performance Curves**  $V_{SUPPLY} = \pm 5V$ ,  $T_A = 25^\circ C$ ,  $R_L = 100\Omega$ , Unless Otherwise Specified (Continued)

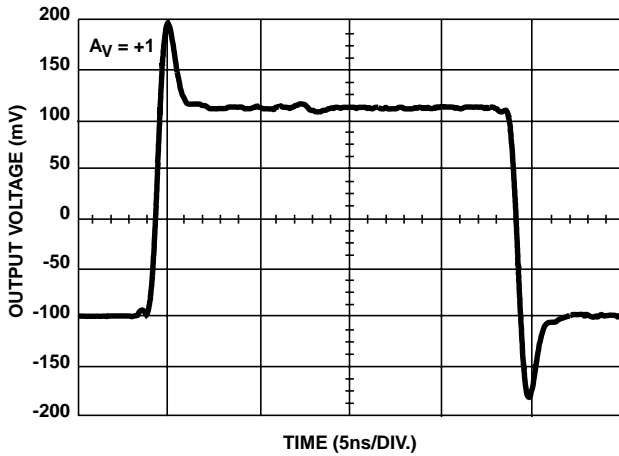

FIGURE 7. SMALL SIGNAL PULSE RESPONSE

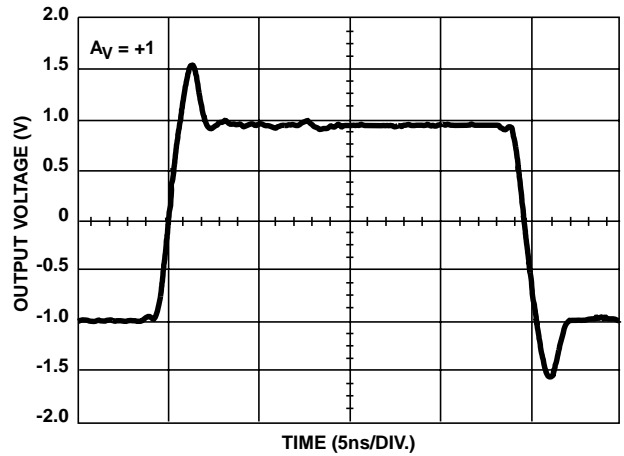

FIGURE 8. LARGE SIGNAL PULSE RESPONSE

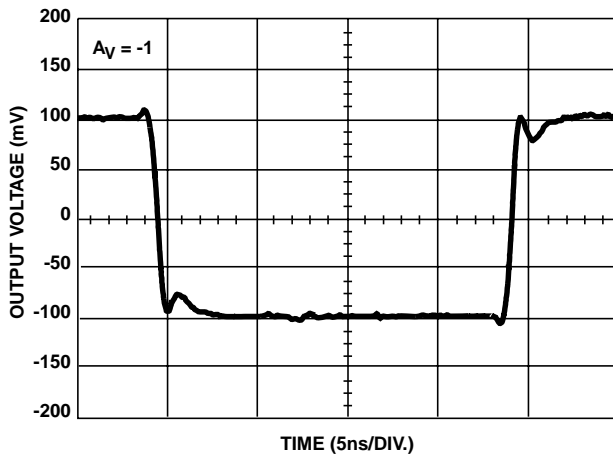

FIGURE 9. SMALL SIGNAL PULSE RESPONSE

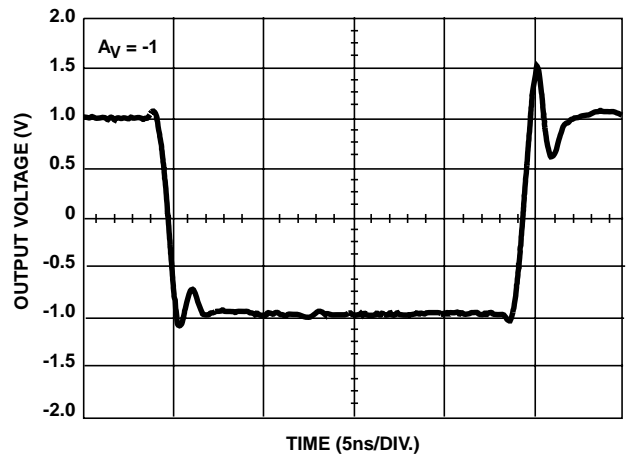

FIGURE 10. LARGE SIGNAL PULSE RESPONSE

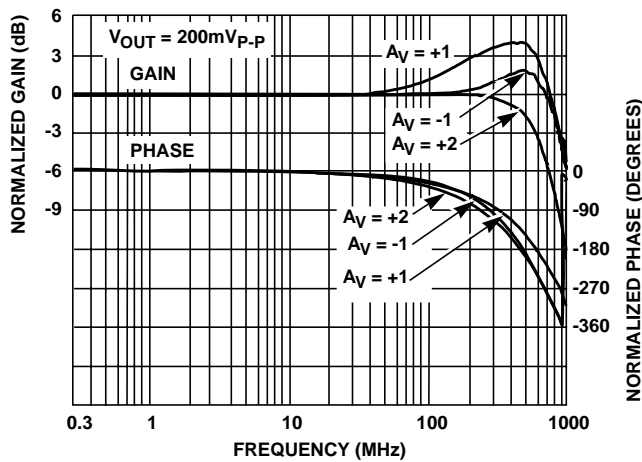

FIGURE 11. FREQUENCY RESPONSE

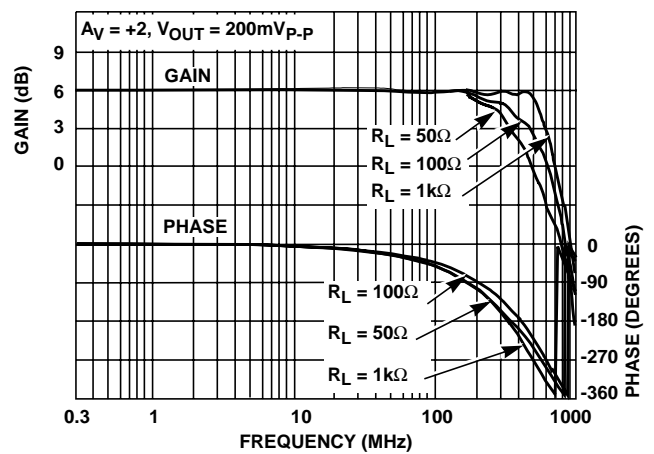

FIGURE 12. FREQUENCY RESPONSE FOR VARIOUS LOAD RESISTORS



**Typical Performance Curves**  $V_{SUPPLY} = \pm 5V$ ,  $T_A = 25^\circ C$ ,  $R_L = 100\Omega$ , Unless Otherwise Specified (Continued)

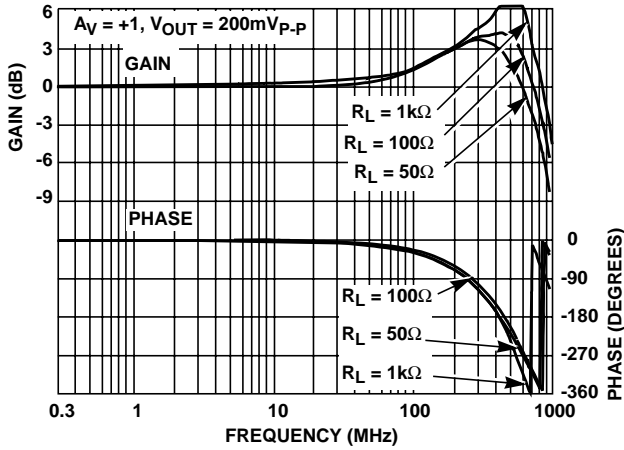

FIGURE 13. FREQUENCY RESPONSE FOR VARIOUS LOAD RESISTORS

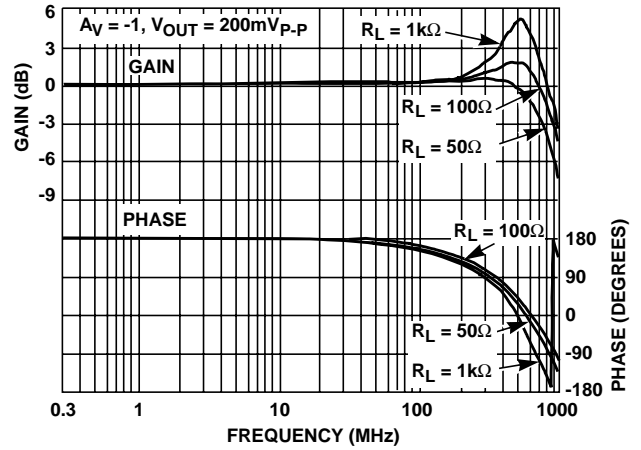

FIGURE 14. FREQUENCY RESPONSE FOR VARIOUS LOAD RESISTORS

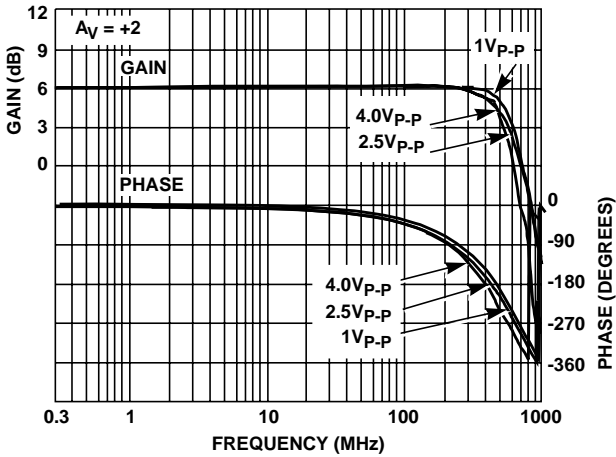

FIGURE 15. FREQUENCY RESPONSE FOR VARIOUS OUTPUT VOLTAGES

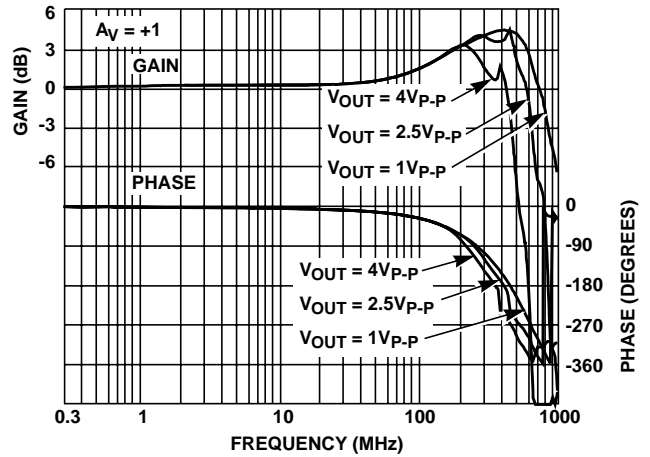

FIGURE 16. FREQUENCY RESPONSE FOR VARIOUS OUTPUT VOLTAGES

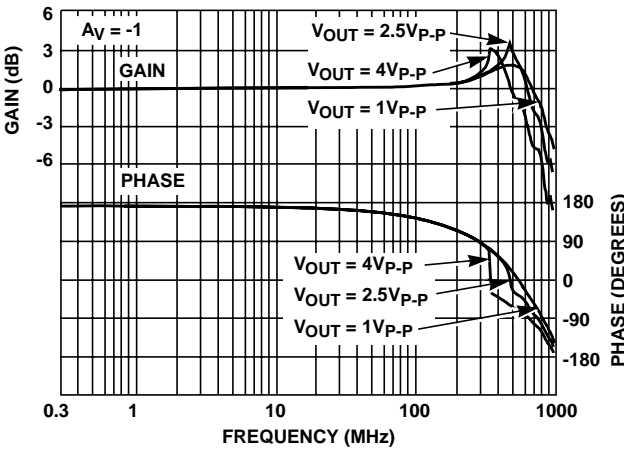

FIGURE 17. FREQUENCY RESPONSE FOR VARIOUS OUTPUT VOLTAGES

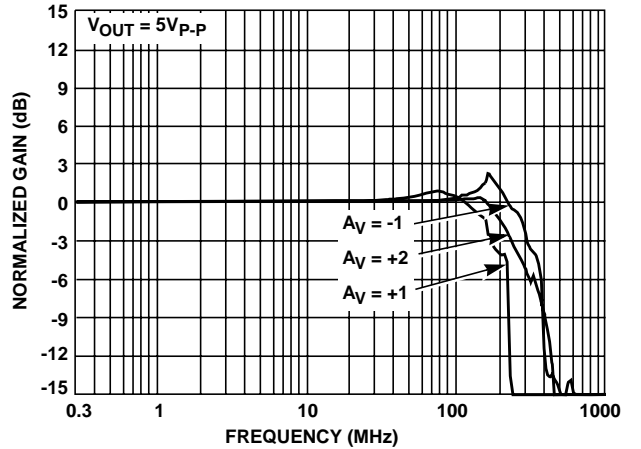

FIGURE 18. FULL POWER BANDWIDTH

**Typical Performance Curves**  $V_{\text{SUPPLY}} = \pm 5\text{V}$ ,  $T_A = 25^\circ\text{C}$ ,  $R_L = 100\Omega$ , Unless Otherwise Specified (Continued)

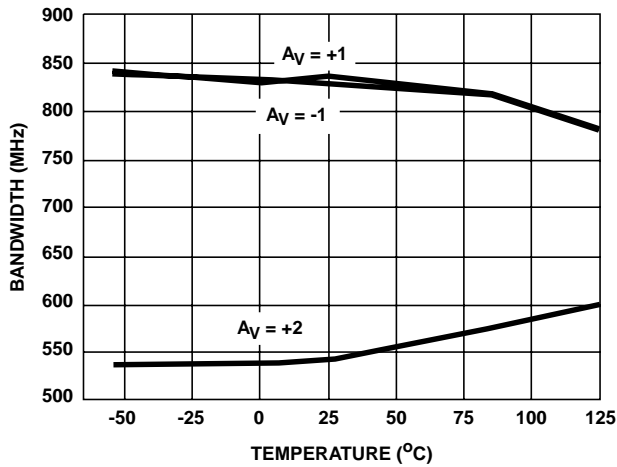

FIGURE 19. -3dB BANDWIDTH vs TEMPERATURE

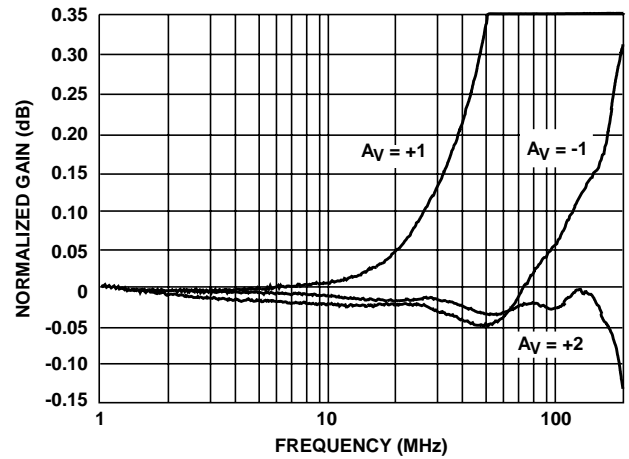

FIGURE 20. GAIN FLATNESS

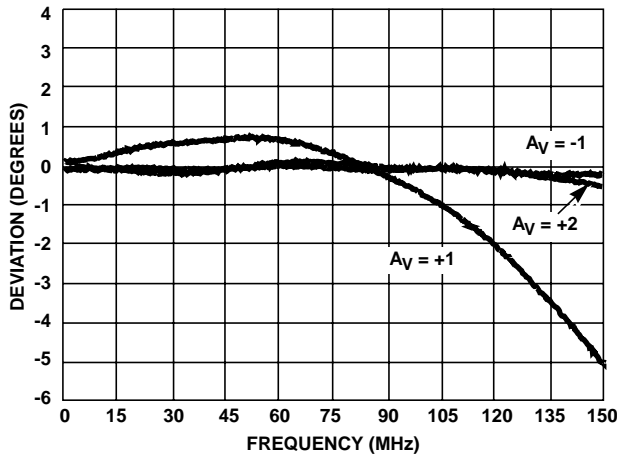

FIGURE 21. DEVIATION FROM LINEAR PHASE

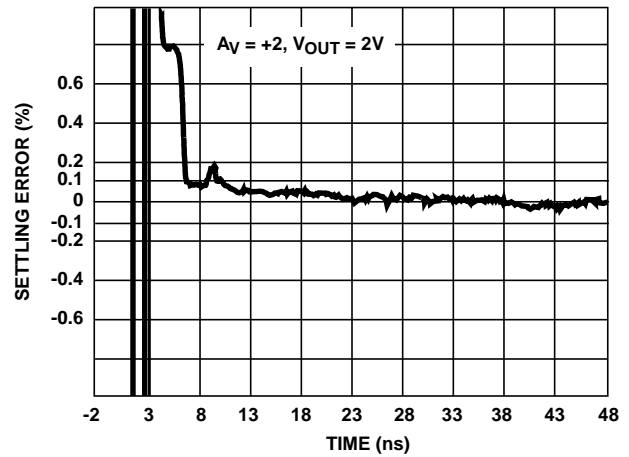

FIGURE 22. SETTLING RESPONSE

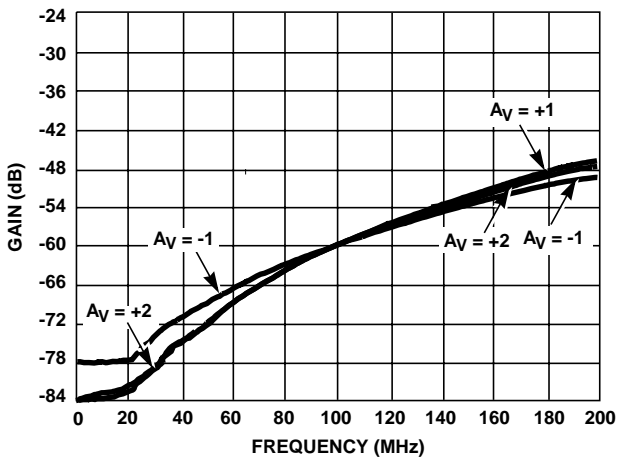

FIGURE 23. LOW FREQUENCY REVERSE ISOLATION ( $S_{12}$ )

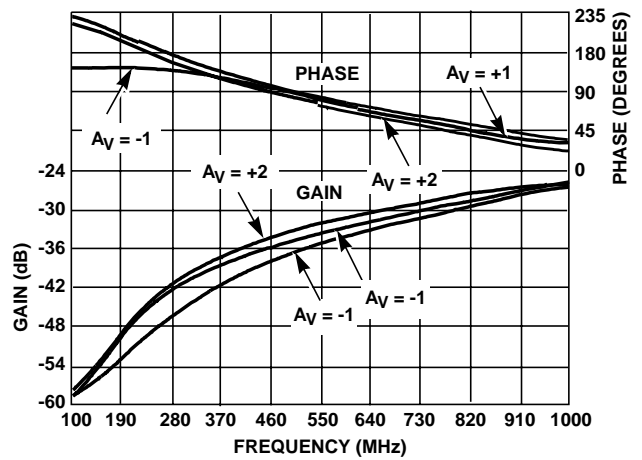

FIGURE 24. HIGH FREQUENCY REVERSE ISOLATION ( $S_{12}$ )

**Typical Performance Curves**  $V_{SUPPLY} = \pm 5V$ ,  $T_A = 25^{\circ}C$ ,  $R_L = 100\Omega$ , Unless Otherwise Specified (Continued)

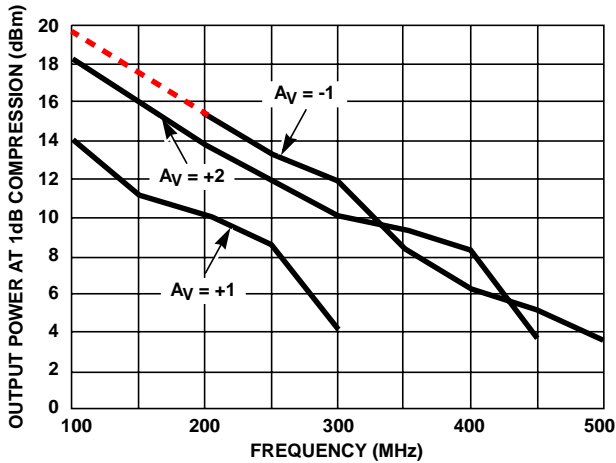

FIGURE 25. 1dB GAIN COMPRESSION vs FREQUENCY

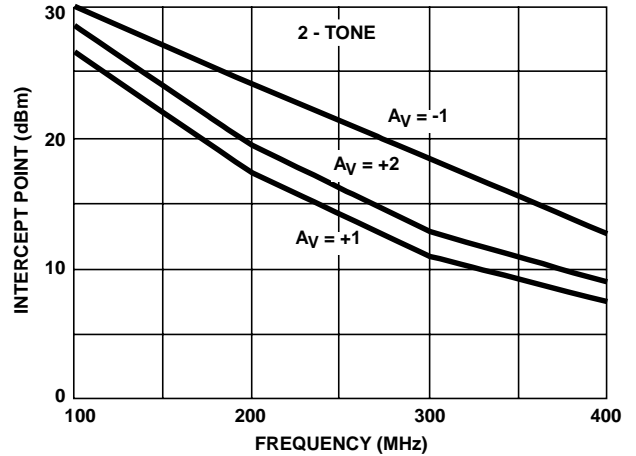

FIGURE 26. THIRD ORDER INTERMODULATION INTERCEPT vs FREQUENCY

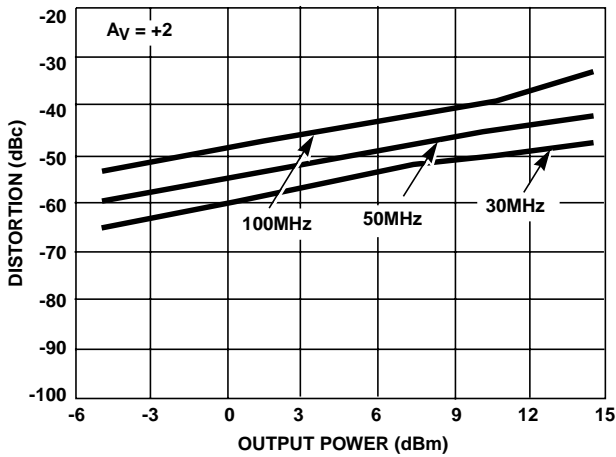

FIGURE 27. SECOND HARMONIC DISTORTION vs  $P_{OUT}$

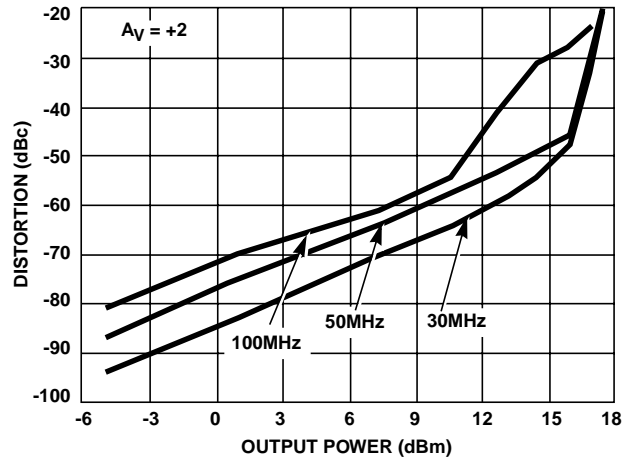

FIGURE 28. THIRD HARMONIC DISTORTION vs  $P_{OUT}$

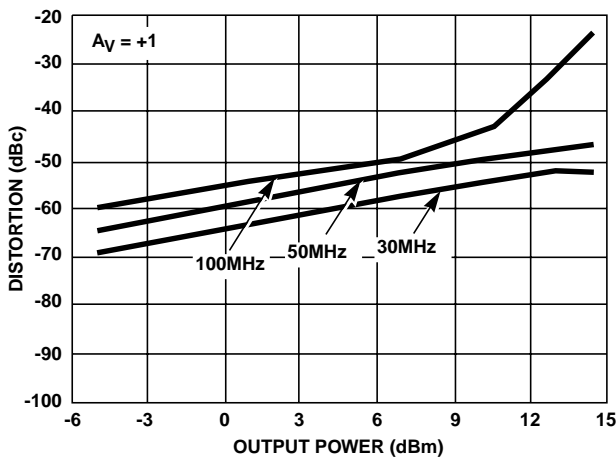

FIGURE 29. SECOND HARMONIC DISTORTION vs  $P_{OUT}$

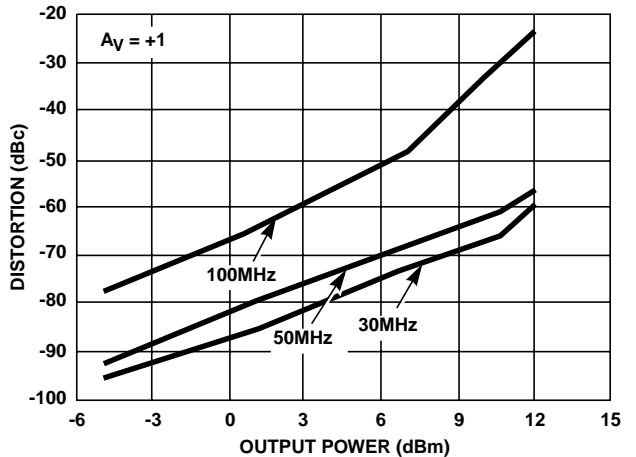

FIGURE 30. THIRD HARMONIC DISTORTION vs  $P_{OUT}$

**Typical Performance Curves**  $V_{SUPPLY} = \pm 5V$ ,  $T_A = 25^\circ C$ ,  $R_L = 100\Omega$ , Unless Otherwise Specified (Continued)

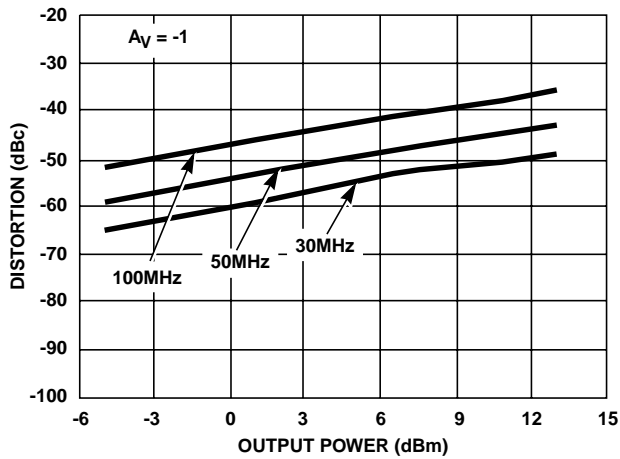

FIGURE 31. SECOND HARMONIC DISTORTION vs  $P_{OUT}$

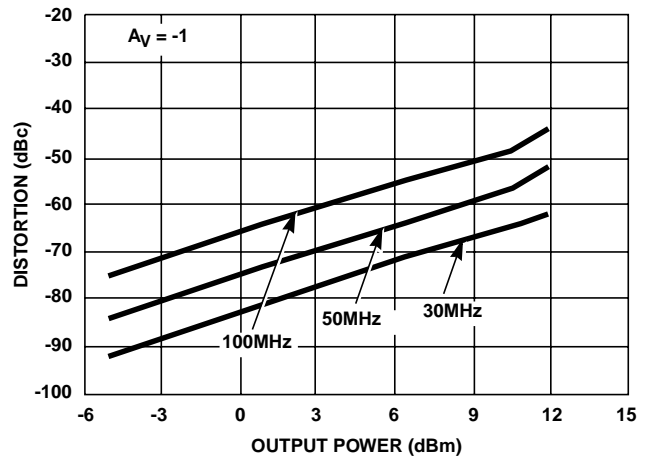

FIGURE 32. THIRD HARMONIC DISTORTION vs  $P_{OUT}$

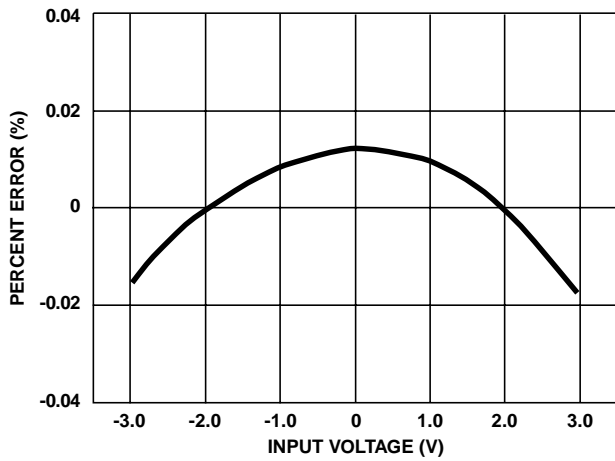

FIGURE 33. INTEGRAL LINEARITY ERROR

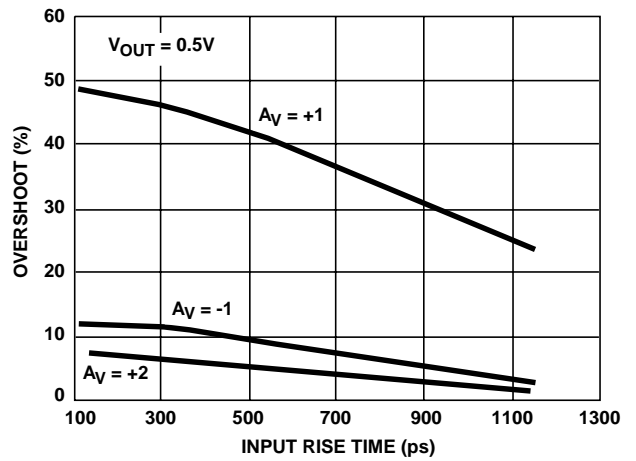

FIGURE 34. OVERSHOOT vs INPUT RISE TIME

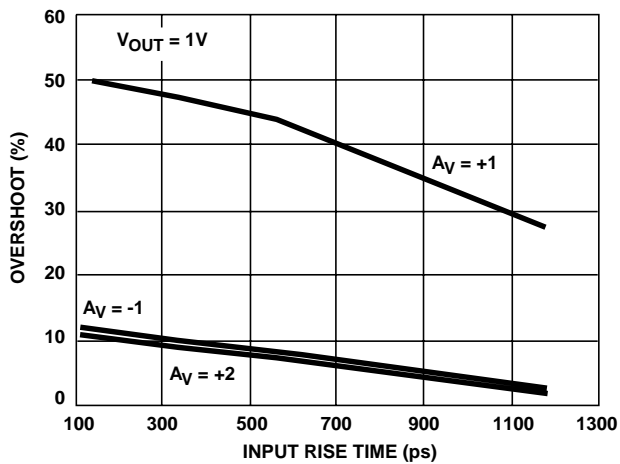

FIGURE 35. OVERSHOOT vs INPUT RISE TIME

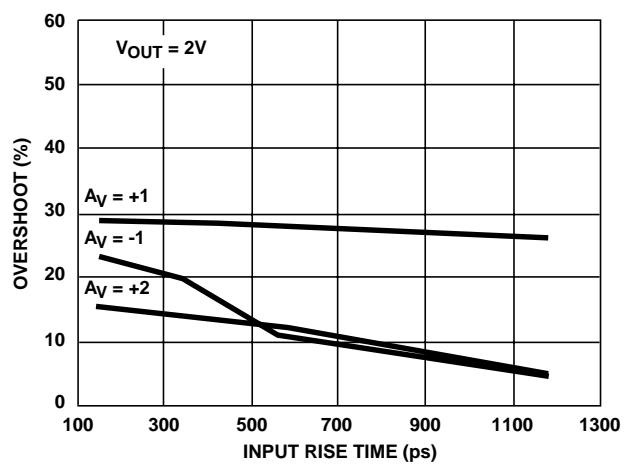

FIGURE 36. OVERSHOOT vs INPUT RISE TIME

**Typical Performance Curves**  $V_{\text{SUPPLY}} = \pm 5\text{V}$ ,  $T_A = 25^\circ\text{C}$ ,  $R_L = 100\Omega$ , Unless Otherwise Specified (Continued)

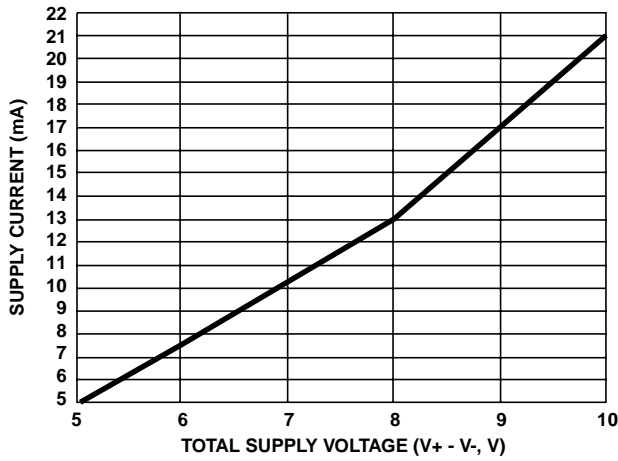

FIGURE 37. SUPPLY CURRENT vs SUPPLY VOLTAGE

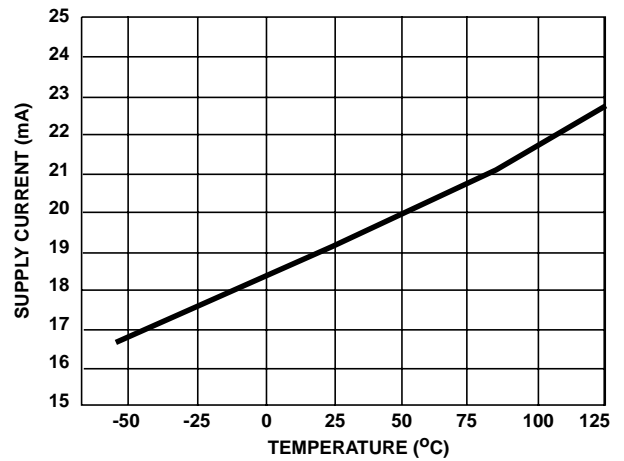

FIGURE 38. SUPPLY CURRENT vs TEMPERATURE

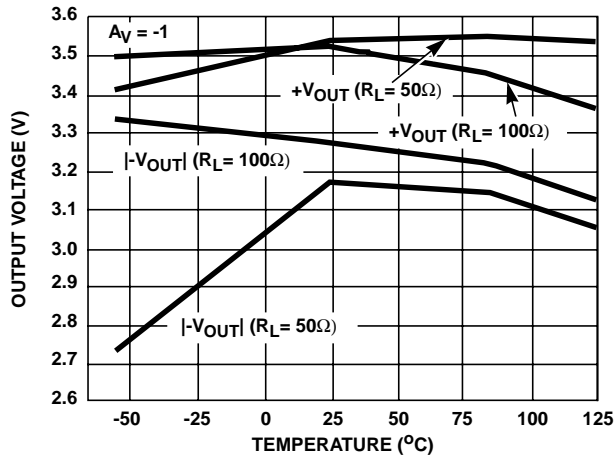

FIGURE 39. OUTPUT VOLTAGE vs TEMPERATURE

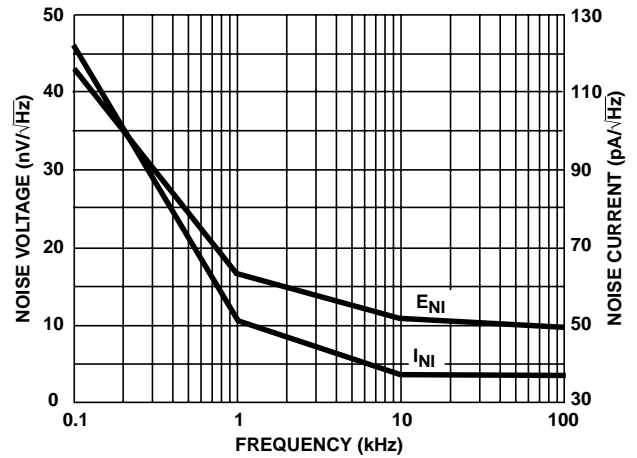

FIGURE 40. INPUT NOISE CHARACTERISTICS

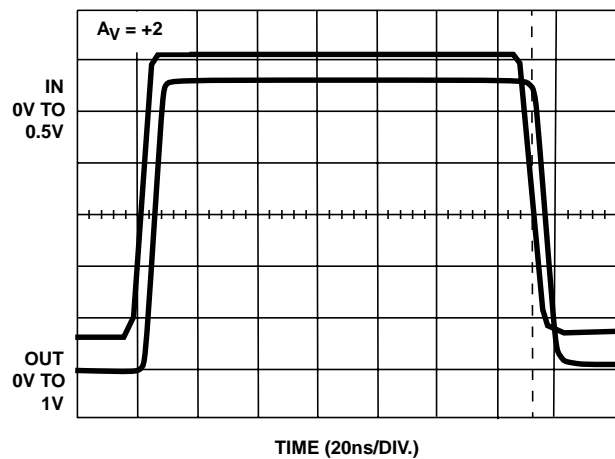

FIGURE 41. UNCLAMPED PERFORMANCE

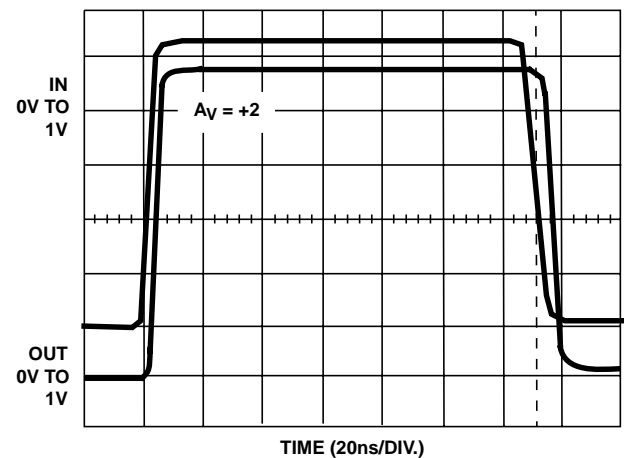

FIGURE 42. CLAMPED PERFORMANCE

**Typical Performance Curves**  $V_{SUPPLY} = \pm 5V$ ,  $T_A = 25^\circ C$ ,  $R_L = 100\Omega$ , Unless Otherwise Specified (Continued)

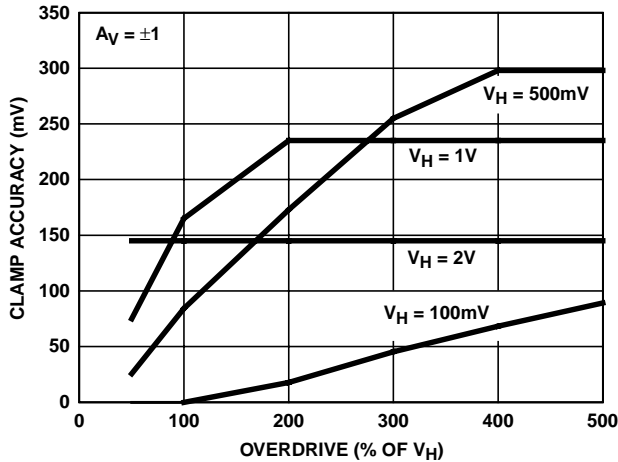

FIGURE 43.  $V_H$  CLAMP ACCURACY vs OVERDRIVE

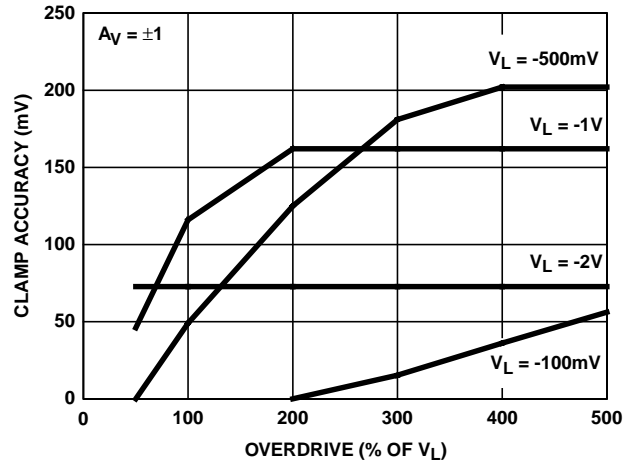

FIGURE 44.  $V_L$  CLAMP ACCURACY vs OVERDRIVE

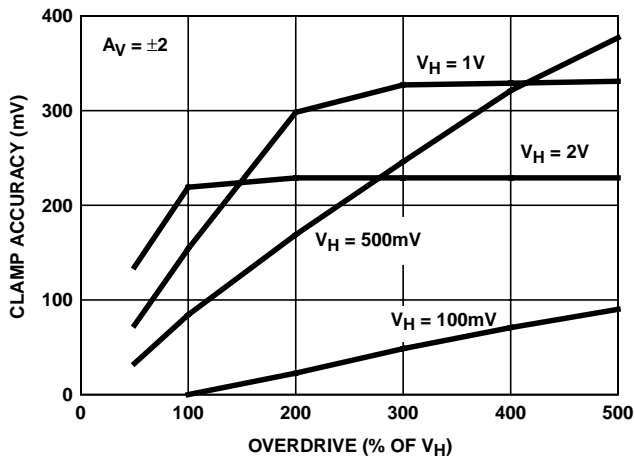

FIGURE 45.  $V_H$  CLAMP ACCURACY vs OVERDRIVE

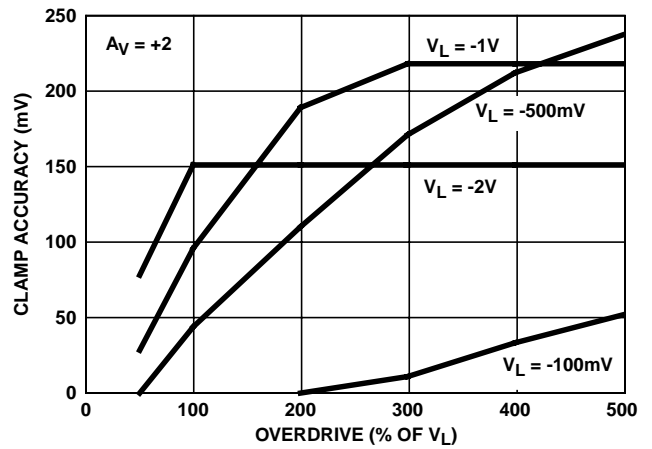

FIGURE 46.  $V_L$  CLAMP ACCURACY vs OVERDRIVE

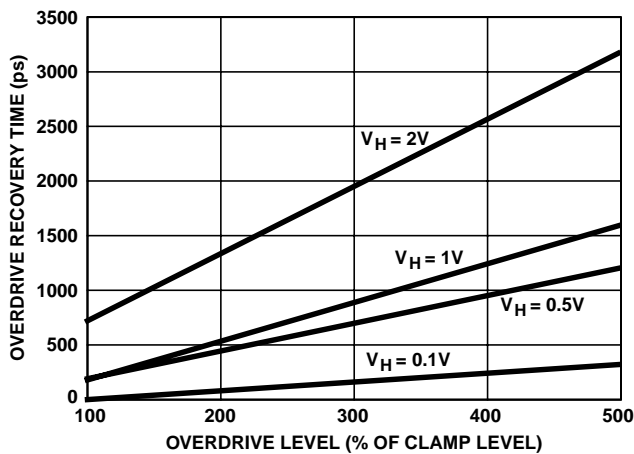

FIGURE 47. OVERDRIVE RECOVERY vs OVERDRIVE

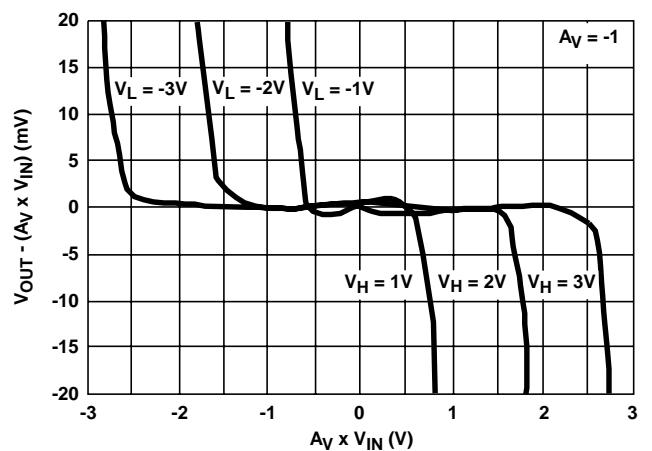

FIGURE 48. NON-LINEARITY NEAR CLAMP VOLTAGE

**Typical Performance Curves**  $V_{SUPPLY} = \pm 5V$ ,  $T_A = 25^\circ C$ ,  $R_L = 100\Omega$ , Unless Otherwise Specified (Continued)

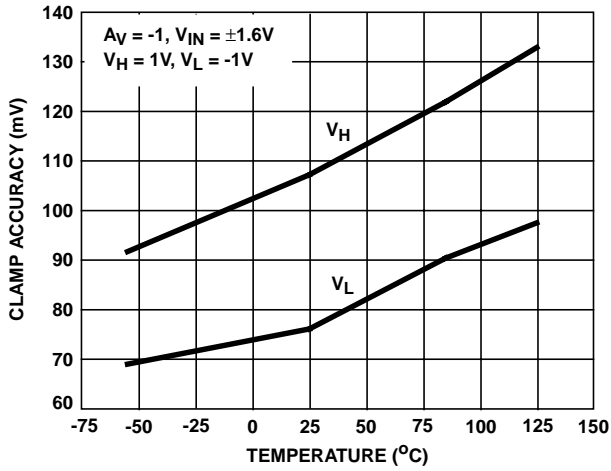

FIGURE 49. CLAMP ACCURACY vs TEMPERATURE

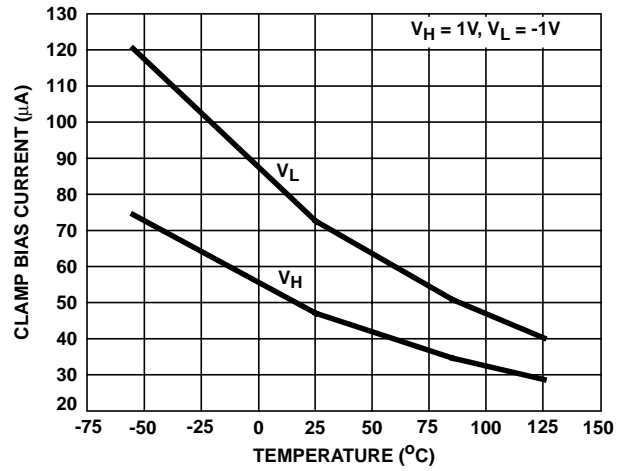

FIGURE 50. CLAMP BIAS CURRENT vs TEMPERATURE

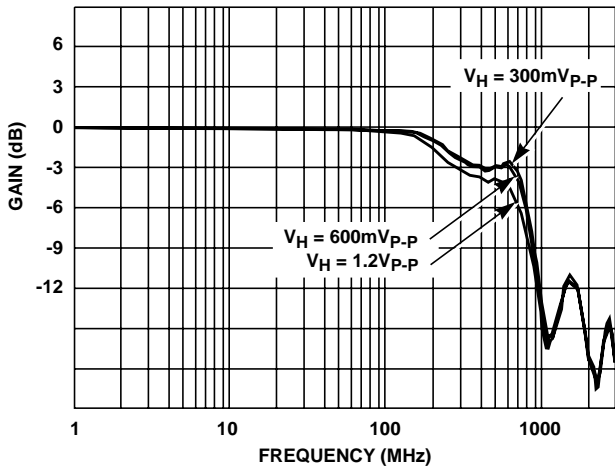

FIGURE 51. V<sub>H</sub> CLAMP INPUT BANDWIDTH

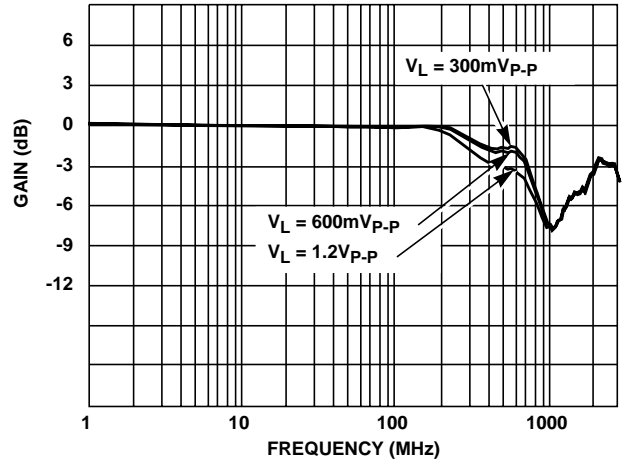

FIGURE 52. V<sub>L</sub> CLAMP INPUT BANDWIDTH

**Die Characteristics**

**DIE DIMENSIONS:**

63 mils x 44 mils x 19 mils  
 1600 $\mu$ m x 1130 $\mu$ m x 483 $\mu$ m

**METALLIZATION:**

Type: Metal 1: AlCu(2%)/TiW  
 Thickness: Metal 1: 8k $\text{\AA}$   $\pm$ 0.4k $\text{\AA}$   
 Type: Metal 2: AlCu(2%)  
 Thickness: Metal 2: 16k $\text{\AA}$   $\pm$ 0.8k $\text{\AA}$

**PASSIVATION:**

Type: Nitride  
 Thickness: 4k $\text{\AA}$   $\pm$ 0.5k $\text{\AA}$

**TRANSISTOR COUNT:**

52

**SUBSTRATE POTENTIAL (POWERED UP):**

Floating (Recommend Connection to V-)

**Metallization Mask Layout**

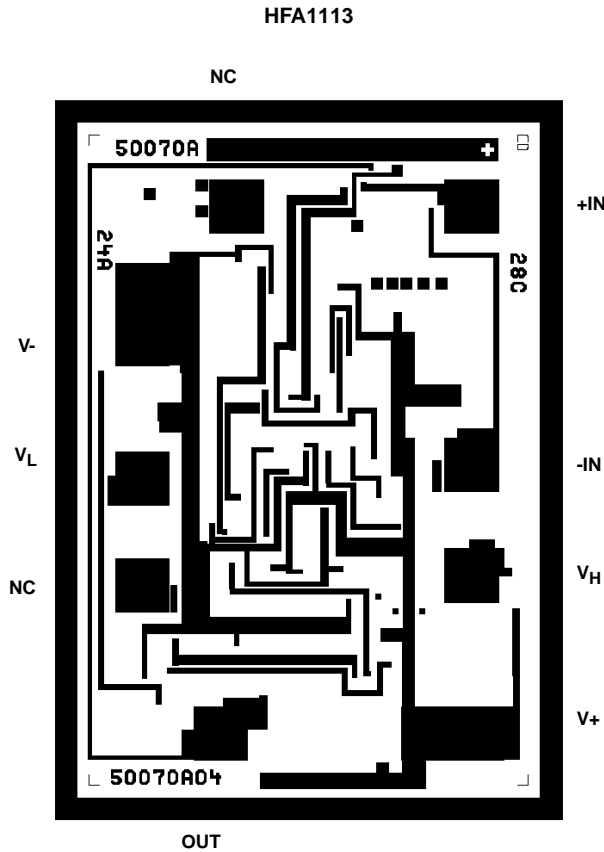



## Small Outline Plastic Packages (SOIC)

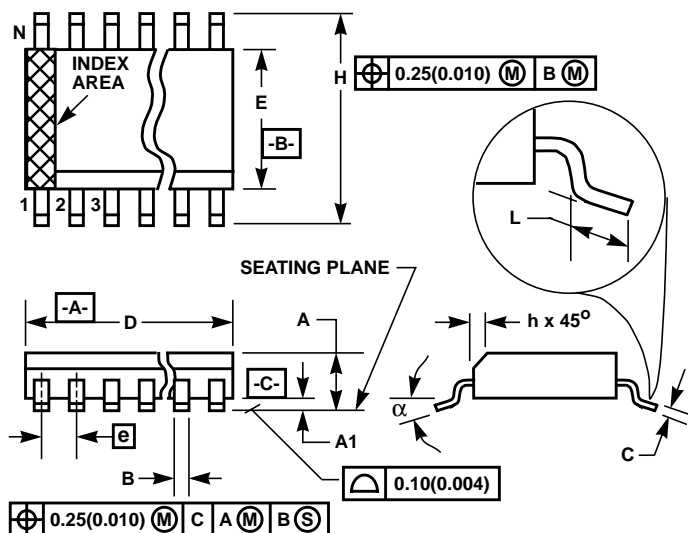

### NOTES:

- Symbols are defined in the "MO Series Symbol List" in Section 2.2 of Publication Number 95.
- Dimensioning and tolerancing per ANSI Y14.5M-1982.
- Dimension "D" does not include mold flash, protrusions or gate burrs. Mold flash, protrusion and gate burrs shall not exceed 0.15mm (0.006 inch) per side.
- Dimension "E" does not include interlead flash or protrusions. Interlead flash and protrusions shall not exceed 0.25mm (0.010 inch) per side.
- The chamfer on the body is optional. If it is not present, a visual index feature must be located within the crosshatched area.
- "L" is the length of terminal for soldering to a substrate.
- "N" is the number of terminal positions.
- Terminal numbers are shown for reference only.
- The lead width "B", as measured 0.36mm (0.014 inch) or greater above the seating plane, shall not exceed a maximum value of 0.61mm (0.024 inch).
- Controlling dimension: MILLIMETER. Converted inch dimensions are not necessarily exact.

### M8.15 (JEDEC MS-012-AA ISSUE C) 8 LEAD NARROW BODY SMALL OUTLINE PLASTIC PACKAGE

SYMBOL	INCHES		MILLIMETERS		NOTES
	MIN	MAX	MIN	MAX	
A	0.0532	0.0688	1.35	1.75	-
A1	0.0040	0.0098	0.10	0.25	-
B	0.013	0.020	0.33	0.51	9
C	0.0075	0.0098	0.19	0.25	-
D	0.1890	0.1968	4.80	5.00	3
E	0.1497	0.1574	3.80	4.00	4
e	0.050 BSC		1.27 BSC		-
H	0.2284	0.2440	5.80	6.20	-
h	0.0099	0.0196	0.25	0.50	5
L	0.016	0.050	0.40	1.27	6
N	8		8		7
$\alpha$	0°	8°	0°	8°	-

Rev. 0 12/93

All Intersil semiconductor products are manufactured, assembled and tested under **ISO9000** quality systems certification.

*Intersil semiconductor products are sold by description only. Intersil Corporation reserves the right to make changes in circuit design and/or specifications at any time without notice. Accordingly, the reader is cautioned to verify that data sheets are current before placing orders. Information furnished by Intersil is believed to be accurate and reliable. However, no responsibility is assumed by Intersil or its subsidiaries for its use; nor for any infringements of patents or other rights of third parties which may result from its use. No license is granted by implication or otherwise under any patent or patent rights of Intersil or its subsidiaries.*

For information regarding Intersil Corporation and its products, see web site [www.intersil.com](http://www.intersil.com)

### Sales Office Headquarters

#### NORTH AMERICA

Intersil Corporation  
P. O. Box 883, Mail Stop 53-204  
Melbourne, FL 32902  
TEL: (321) 724-7000  
FAX: (321) 724-7240

#### EUROPE

Intersil SA  
Mercure Center  
100, Rue de la Fusee  
1130 Brussels, Belgium  
TEL: (32) 2.724.2111  
FAX: (32) 2.724.22.05

#### ASIA

Intersil (Taiwan) Ltd.  
7F-6, No. 101 Fu Hsing North Road  
Taipei, Taiwan  
Republic of China  
TEL: (886) 2 2716 9310  
FAX: (886) 2 2715 3029